

ACTIVE/SYNCHRONOUS RECTIFICATION CONTROLLER

Description

The AR2003FV is Active/Synchronous Rectification Controller, providing output voltage from 4.5V to 21V. Using internal drain-to-source voltage sensing, the AR2003FV is ideal for Fly-back, LLC-resonant and other power supply architectures. It has SFB pin that can eliminate the external feedback resistor when target output voltage is 5V or 12V.

The small footprint of the AR2003FV makes it ideal for space constrained applications.

Intelligent features of this IC are the Minimum Off Time (TOFF) and Minimum on Time (TON), these features blank the noise generated during the turn on and turn off instances of the power FET. Light load detection for improved efficiency at light and no load is implemented. Other features include Under Voltage Lock Out (UVLO), SYNC feature for CCM operation and low turn off threshold voltage for improved efficiency.

Pin Assignments

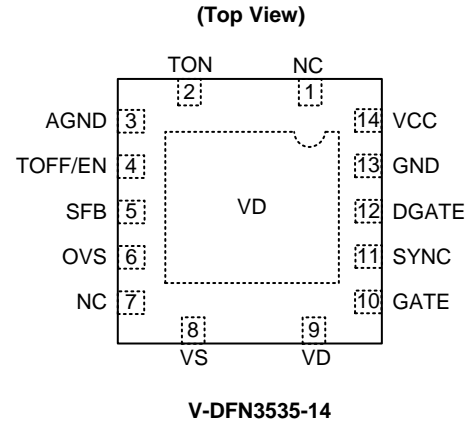

Features

- Primary-Side or Secondary-side Active/Synchronous Rectification, Optimized for Systems with Dynamic Voltage Scaling Capabilities
- Frequency of Operation up to 600kHz
- Suitable for Discontinuous (DCM), Continuous (CCM) and Critical (CrCM) Conduction Mode
- Minimum On-time and Off-time to Blanking Turn-on/off Oscillations
- Light Load Detection and Sleep Mode
- Drain Voltage Rating of 200V
- Recommended Operating Voltage from 4.5V up to 21V
- Low Component Count.
- Low Under Voltage Lockout
- **Totally Lead-Free & Fully RoHS Compliant (Notes 1 & 2)**
- **Halogen and Antimony Free. "Green" Device (Note 3)**

Applications

- USB PD Adaptor
- AC-DC Battery Charger
- Fly-back Conversion
- PC Power Supply
- SMPS
- Power Adaptors
- Auxiliary Power Supplies
- PoE Power Devices

Notes:

1. No purposely added lead. Fully EU Directive 2002/95/EC (RoHS) & 2011/65/EU (RoHS 2) compliant.
2. See http://www.diodes.com/quality/lead_free.html for more information about Diodes Incorporated's definitions of Halogen- and Antimony-free, "Green" and Lead-free.
3. Halogen- and Antimony-free "Green" products are defined as those which contain <900ppm bromine, <900ppm chlorine (<1500ppm total Br + Cl) and <1000ppm antimony compounds.

Pin Descriptions

| Pin Number | Pin Name | Function |
|------------|----------|--|
| 1, 7 | NC | Not Connected |
| 2 | TON | Minimum On-time Setting Pin |
| 3 | AGND | This is the ground reference for all internal comparators and thresholds. |
| 4 | TOFF/EN | <p>Enable Pin/ Minimum Off-time</p> <p>This pin combines the functions of setting the programmable minimum off-time as well as acting as the enable pin. The device enters Under Voltage Lock Out (UVLO) mode when VCC falls below the UVLO threshold. At this point the TOFF/EN pin is internally shorted to ground through a resistor. The internal current source (used for setting TOFF) is powered down. Once the UVLO threshold is exceeded, the internal resistance is removed and the current source is activated. If the voltage applied to the TOFF/EN pin exceeds the VEN_{ON} threshold then the device is in Active Mode. If the voltage drops below the VEN_{OFF} threshold then the device is in Sleep Mode.</p> |
| 5 | SFB | Output pin of internal feedback resistor which is connected to VCC. It is sent to TL431 (or its compatible) to drive the opto-coupler and provide feedback voltage to primary side controller to realize Secondary Synchronous Rectification. |
| 6 | OVS | Output voltage (VCC) select pin, work together with SFB to select output voltage in 5V or 12V. |
| 8 | VS | This is the connection to internal MOSFET Source. VS is also connected to GND. |
| 9, VD pad | VD | This is a connection to the internal MOSFET Drain. The pin needs to be connected as closely as possible to the transformer used in the application, to minimize the effects of parasitic inductance on the performance of the device. The device requires that VD has a voltage greater than 1.5V and that the T _{OFF} timer has expired before the MOSFET is able to be activated. Once these conditions are met and the voltage internally sensed on the VD pin is 150mV lower than the VS pin, the internal MOSFET is turned on and the T _{ON} minimum on time period is started. The MOSFET will remain on for at least the length of the minimum on time. The only thing that can override this is if a pulse is detected on the S _{NYC} pin. After the T _{ON} period, the MOSFET remains on until the VD to VS voltage has reached to the V _{THOFF} threshold, at which point the internal MOSFET is turned off. As mentioned before, if the V _{THOFF} threshold is reached before the T _{ON} period has expired, the device will enter the Light Load Mode. Under this mode, the MOSFET will not be turned on the next switching cycle. When the drain voltage has increased to 1.5V, the TOFF timer is triggered, during which the MOSFET is prevented from turning on. |
| 10 | GATE | Connect GATE to the gate of the controlled MOSFET through a small series resistor using short PC board tracks to achieve optimal switching performance. The GATE output can achieve >2-A peak source current when High and >4-A peak sink current when Low into a large N-channel power MOSFET. |
| 11 | SYNC | If a falling edge is sensed on this pin, the internal MOSFET is immediately turned off, irrespective of the sensed drain to source voltage or the state of the TON timer. This characteristic allows the device to be easily used in a Continuous Conduction Mode (CCM) system. The SYNC pin needs to be connected to a suitable control signal on the primary side of the convertor, using a high voltage isolation cap, transformer or other suitable means. |
| 12 | DGATE | During Over Voltage Protection, DGATE will drive external MOSFET to pull down the output voltage so that Primary side controller will start the Short Circuit Protection handling. |
| 13 | GND | This is the reference potential for all internal comparators and thresholds. |
| 14 | VCC | VCC supplies all the internal circuitry of the device. A DC supply is required to be connected to this pin. It is required that a 10µF or larger capacitor is placed between this pin and GND, as close to the pins as possible. The device will not function until the VCC has risen above the UVLO threshold. The device can safely be turned off by bringing VCC below the UVLO threshold (minus the UVLO threshold hysteresis). If VCC drops below the UVLO threshold (minus UVLO threshold hysteresis), the MOSFET is turned off and the TOFF/EN pin is internally connected to GND. |

Functional Block Diagram

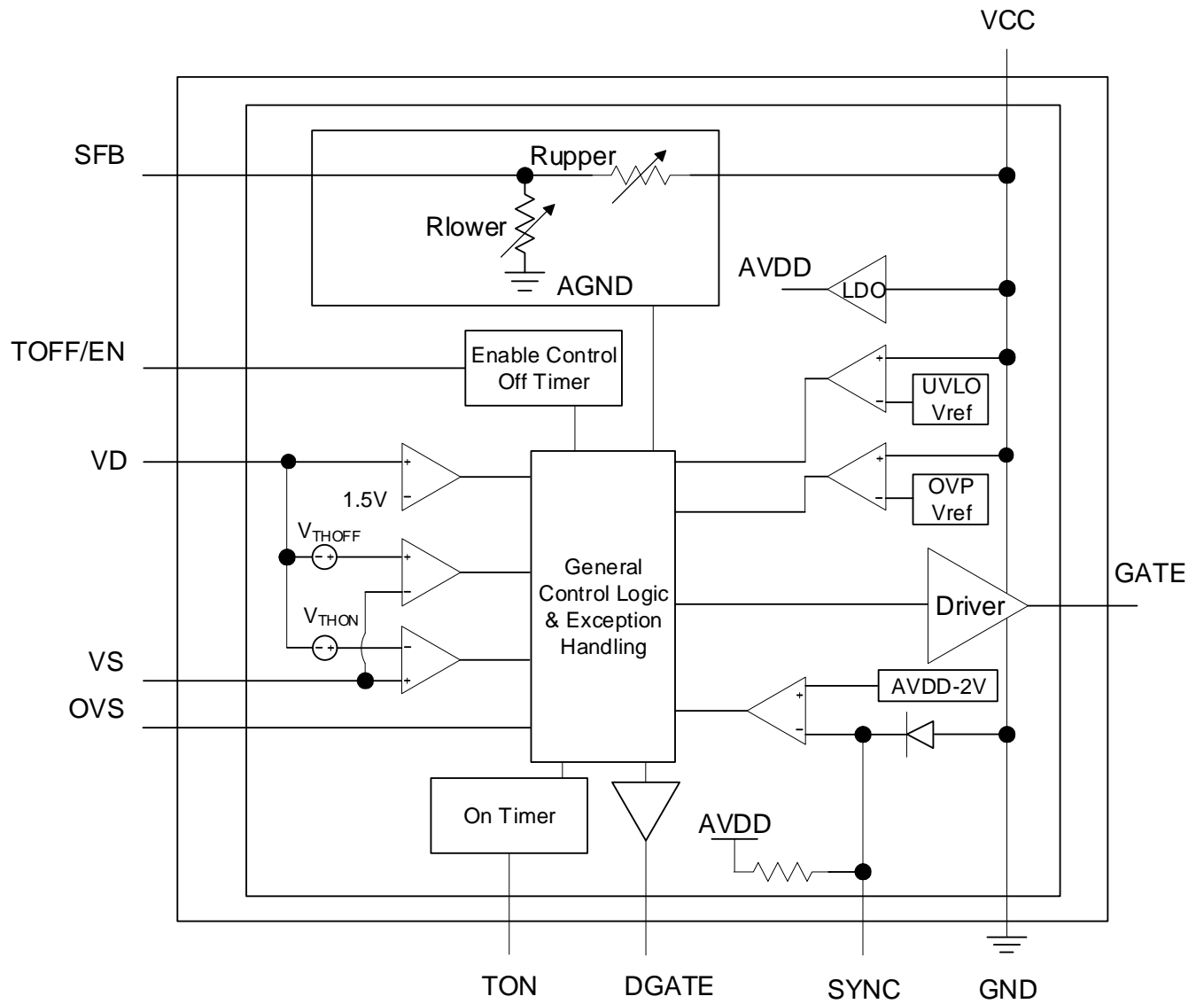

Absolute Maximum Ratings (Note 4)

| Symbol | Parameter | Rating | Unit |
|-------------------------|-----------------------------------|-------------|------|
| VCC | Input Voltage Range VCC | -0.3 to 24 | V |
| VD | Input Voltage Range VD | -1 to 200 | V |
| VS | Input Voltage Range VS | -1 to 1 | V |
| TOFF/EN, TON, OVS, SYNC | Input Voltage Range Other | -0.3 to 6 | V |
| T _J | Operating Junction Temperature | -40 to +150 | °C |
| T _L | Lead Temperature | + 260 | °C |
| T _{ST} | Storage Temperature | -65 to +150 | °C |
| ESD | Human Body Model, JESD22-A114 | 2 | kV |
| | Charged Device Model, JESD22-C101 | 0.5 | |

Note 4: These are stress ratings only. Operation outside the absolute maximum ratings may cause device failure. Operation at the absolute maximum rating for extended periods may reduce device reliability.

Package Thermal Data (@T_A = +25°C, unless otherwise specified)

| Symbol | Parameter | Rating | Unit |
|------------------|--|--------|------|
| P _D | Power Dissipation (Note 5) | 0.67 | W |
| R _{θJA} | Thermal Resistance, Junction to Ambient Air (Note 6) | 36 | °C/W |
| R _{θJC} | Thermal Resistance, Junction to Case (Note 7) | 21 | °C/W |

Notes: 5. Device mounted on FR-4 PCB, 2oz with minimum recommended pad layout.
 6. Device mounted on 25mm x 25mm 2oz copper board.
 7. Device mounted on 50mm x 50mm 2oz copper board.

Recommended Operating Conditions

| Symbol | Parameter | Min | Max | Unit |
|--------------------|--------------------------------------|------|------|------|
| V _{CC} | Supply Voltage Range | 4.5 | 21 | V |
| V _{DS} | Voltage Cross Drain and Source | -1 | 200 | |
| f _{SW} | Switching Frequency | 20 | 600 | kHz |
| T _J | Operating Junction Temperature Range | -40 | +125 | °C |
| R _{TOFF} | TOFF Resistor Value | 85 | 200 | kΩ |
| R _{TON} | TON Resistor Value | 8.25 | 100 | kΩ |
| C _{VCC} | VCC Bypass Capacitor | 10 | – | μF |
| TW _{sync} | Sync Pulse Width | 20 | – | nS |

Electrical Characteristics (@ $T_A = +25^{\circ}\text{C}$, unless otherwise specified.)

| Symbol | Parameter | Conditions | Min | Typ | Max | Unit |
|-------------------------------------|--|--|-------|------|-------|---------------|
| V_{AVDD} | Internal Regulator Output | $V_{CC} = 5.5\text{V}$ | – | 4.5 | – | V |
| | | $V_{CC} = 12\text{V}$ | – | 4.7 | – | V |
| ICC_{START} | Supply Current (Under Voltage) | $V_{CC} = 2.6\text{V}$ | – | 160 | 220 | μA |
| $ICC_{STANDBY}$ | Supply Current (Disabled) | $V_{CC} = 5.5\text{V}, R_{EN/OFF} = 0\Omega$ | – | 380 | 500 | |
| | | $V_{CC} = 12\text{V}, R_{EN/OFF} = 0\Omega$ | – | 450 | 600 | |
| ICC_{ON} | Supply Current (Enabled) | $V_{CC} = 5.5\text{V}, R_{EN/OFF} = 100\text{k}\Omega, C_{gate}=0.$ | – | 1.5 | 2 | mA |
| | | $V_{CC} = 12\text{V}, R_{EN/OFF} = 100\text{k}\Omega, C_{gate}=0.$ | – | 1.8 | 2.5 | |
| | | $V_{CC} = 5.5\text{V}, f_{sw}=100\text{kHz}, C_{gate}=3300\text{pf}$ | – | 3.2 | 4.2 | |
| | | $V_{CC} = 12\text{V}, f_{sw}=100\text{kHz}, C_{gate}=3300\text{pf}$ | – | 5 | 7 | |
| V_{EN-ON} | TOFF/EN Turn-on Threshold, Rising | TOFF/EN driven, $V_{TON} > 0.6\text{V}$ | 1.31 | 1.4 | 1.49 | V |
| V_{EN-OFF} | TOFF/EN Turn-off Threshold, Falling | TOFF/EN driven, $V_{TON} < 0.2\text{V}$ | 0.55 | 0.6 | 0.65 | |
| $I_{EN-START}$ | TOFF/EN Input Current, Disabled | $R_{TOFF}=50\text{K}$ | -21.5 | -20 | -18.5 | μA |
| I_{EN-ON} | TOFF/EN Input Current, Enabled | $R_{TOFF}=100\text{K}$ | -10.7 | -10 | -9.3 | |
| Under-Voltage Lockout (UVLO) | | | | | | |
| $UVLO_{TH}$ | VCC Under Voltage Lockout Threshold Rising | – | 2.8 | 3.0 | 3.20 | V |
| $UVLO_{HYS}$ | VCC Under Voltage Lockout Threshold Hysteresis | – | – | 200 | – | mV |
| MOSFET Voltage Sensing | | | | | | |
| V_{THARM} | Gate Re-arming Threshold | V_D to GND, Rising | 1.3 | 1.5 | 1.7 | V |
| V_{THON} | Gate Turn-on Threshold | (V_D-V_S) falling, $V_S = 0\text{V}$ | -220 | -150 | -80 | mV |
| $V_{THOFF HV}$ | Gate Turn-off Threshold | (V_D-V_S) rising, $V_S = 0\text{V}, V_{CC} \geq 4.2\text{V}$ | -6 | -4 | -2 | mV |
| $V_{THOFF LV}$ | Gate Turn-off Threshold | V_D-V_S rising, $V_S = 0\text{V}, V_{CC} < 4.2\text{V}$ | -30 | -20 | -10 | |
| TD_{ON} | Gate Turn-on Propagation Delay | From V_{THON} to Gate $> 1\text{V}$ | – | 30 | 50 | ns |
| TD_{OFF} | Gate Turn Off Propagation Delay | From V_{THOFF} to Gate $< 4\text{V}$ | – | 30 | 60 | ns |
| Minimum On Time | | | | | | |
| T_{ON-LR} | Minimum On Time at Low Resistance | $R_{TON} = 8.25\text{K}\Omega$ | 0.26 | 0.34 | 0.42 | μs |
| T_{ON-HR} | Minimum On Time at High Resistance | $R_{TON} = 100\text{K}\Omega$ | 2.25 | 3 | 3.75 | μs |
| Minimum Off Time | | | | | | |
| T_{OFF-LR} | Minimum Off Time at Low Resistance | $R_{TOFF} = 100\text{K}\Omega$ | 0.8 | 1.4 | 2 | μs |
| T_{OFF-HR} | Minimum Off Time at High Resistance | $R_{TOFF} = 200\text{K}\Omega$ | 7.5 | 10 | 12.5 | μs |
| T_{OFF-LV} | Minimum Off Time at Low Voltage | $V_{EN/TOFF}=1\text{V}$ | 0.8 | 1.4 | 2 | μs |
| T_{OFF-HV} | Minimum Off Time at High Voltage | $V_{EN/TOFF}=2\text{V}$ | 7.5 | 10 | 12.5 | μs |
| T_{OFF-OV} | Minimum Off Time at Over Voltage | $2\text{V} < V_{EN/TOFF} < V_{AVDD}$ | 7.5 | 10 | 12.5 | μs |

Electrical Characteristics (@T_A = +25°C, unless otherwise specified.) (Cont.)

| Symbol | Parameter | Conditions | Min | Typ | Max | Unit |
|--------------------------------|--|---|------------------------|------------------------|------------------------|------|
| Over Voltage Protection | | | | | | |
| V _{OVP0H} | Output Over Voltage High Threshold when OVS = 0 | – | – | 6 | – | V |
| V _{OVP0L} | Output Over Voltage Low Threshold when OVS = 0 | – | – | 5.4 | – | V |
| Synchronization | | | | | | |
| V _{THSYNC} | SYNC Falling Threshold | Gate Output from High to Low | V _{AVDD} -2.4 | V _{AVDD} -2.0 | V _{AVDD} -1.6 | V |
| T _{SDLY} | SYNC Propagation Delay (Note 8) | SYNC falling to Gate Falling 10%, 4.5V < V _{CC} < 5.5V | – | 40 | 70 | ns |
| R _{SYNC} | SYNC Pull Up Resistance (Note 8) | Internal Resistance from SYNC to V _{CC} , 4.5V < V _{CC} < 5.5V | 1.6 | 2.0 | 2.4 | KΩ |
| Gate Driver | | | | | | |
| R _{GUP} | Gate Pull up Resistance Enabled | I _{gate} =-100mA | – | 2.3 | 4 | Ω |
| R _{GDN} | Gate Pull Down Resistance Enabled | I _{gate} =100mA | – | 1.1 | 2 | |
| V _{OHG} | Gate Output High Voltage | I _{gate} =-100mA, V _{CC} =5V | 4.7 | -- | – | V |
| | | I _{gate} =100mA, V _{CC} >10V | 9.5 | -- | – | |
| V _{OLG} | Gate Output Low Voltage | I _{gate} =100mA, V _{CC} =0V | – | -- | 0.3 | |
| T _{fgate} | Gate Fall Time | 4V to 1V, C _{gate} = 3300pf | – | 14 | 30 | ns |
| | | 10V to 1V, C _{gate} =3300pf | – | 20 | 35 | |
| T _{rgate} | Gate Rise Time | 1V to 4V, C _{gate} = 3300pf | – | 16 | 35 | |
| | | 1V to 10V, C _{gate} = 3300pf | – | 25 | 40 | |
| T _{DIS} | Disable Delay (note 8) | EN falling to Gate falling | – | 160 | 200 | |
| Exception Handling | | | | | | |
| T _{over} | Over Temperature | – | – | +150 | – | °C |
| T _{recover} | Temperature to Recover from Over Temperature Exception | – | – | +125 | – | °C |
| T _{dgate} | Delay of Turn On Pull Down MOSFET | C _{dgate} =400pf | – | 1.5 | – | uS |

Note 8: Guaranteed by design.

Typical Performance Characteristics

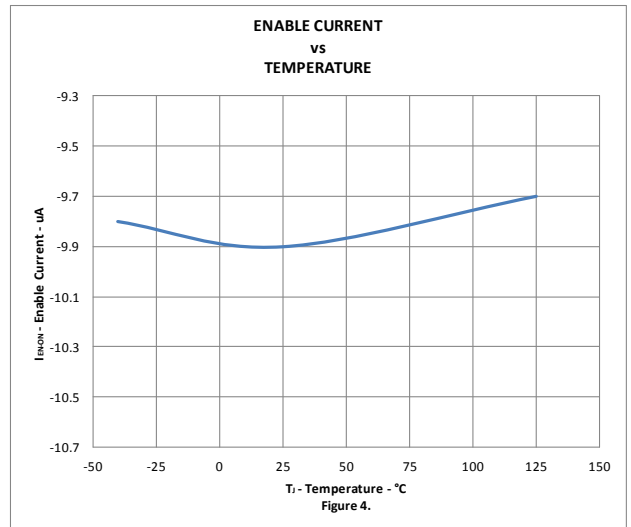
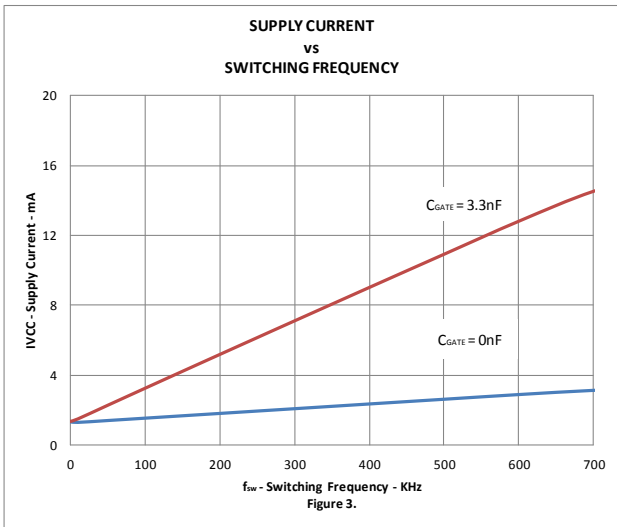
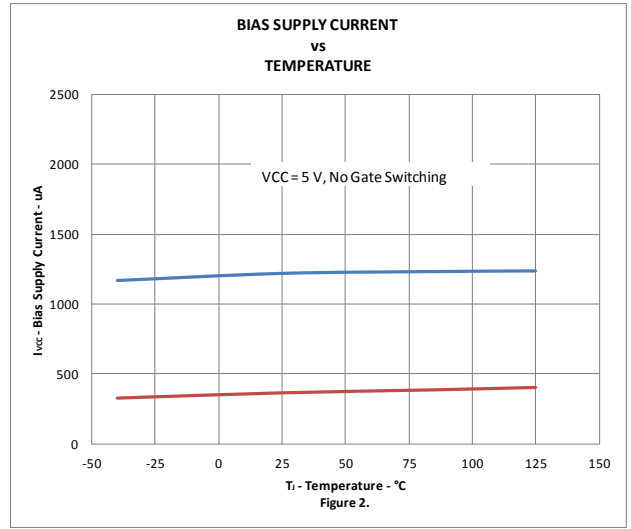
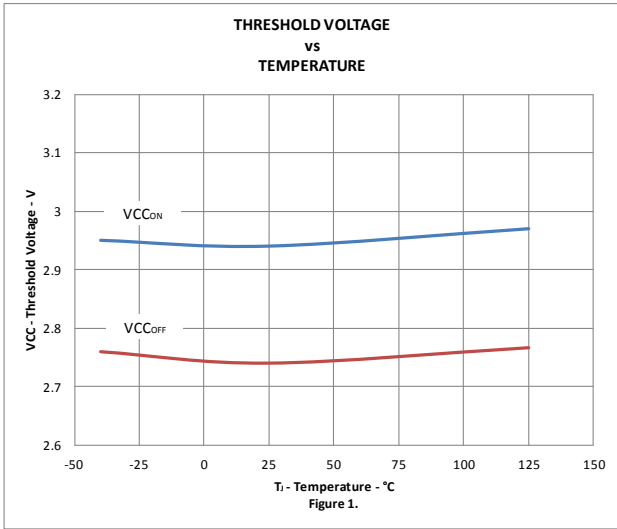

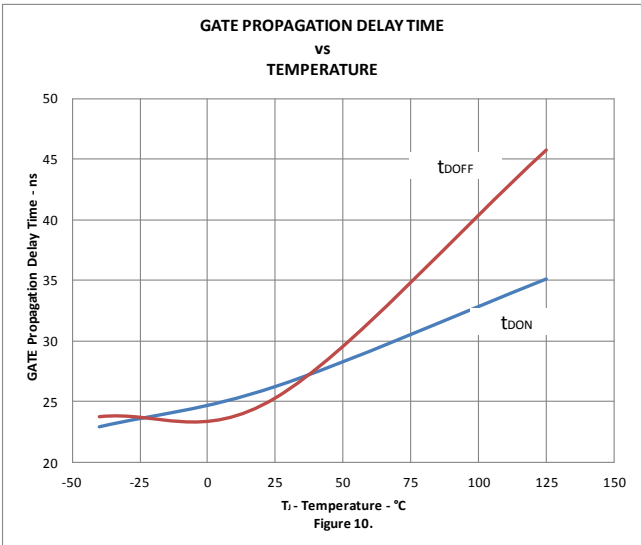
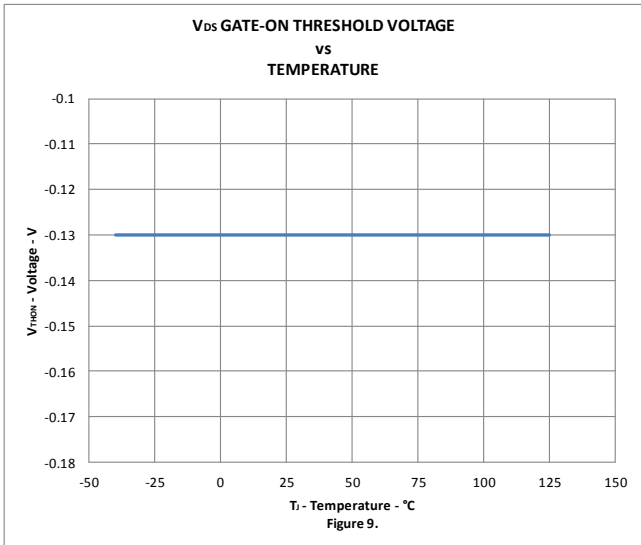
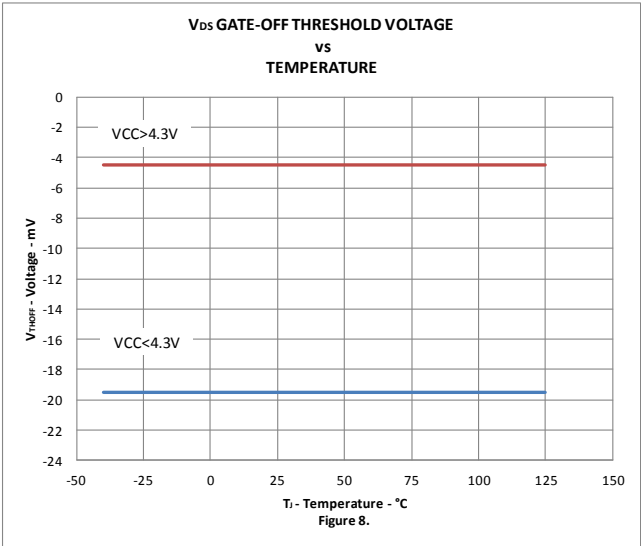
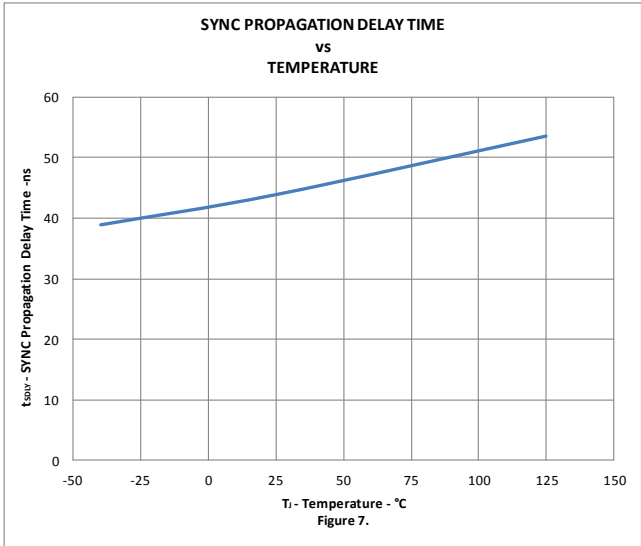
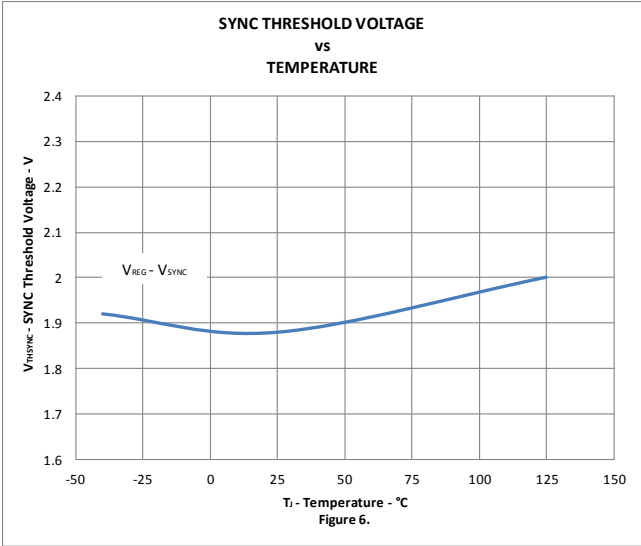
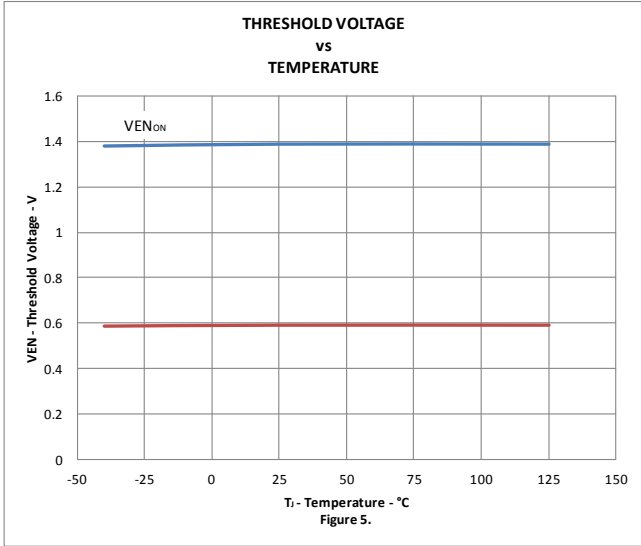

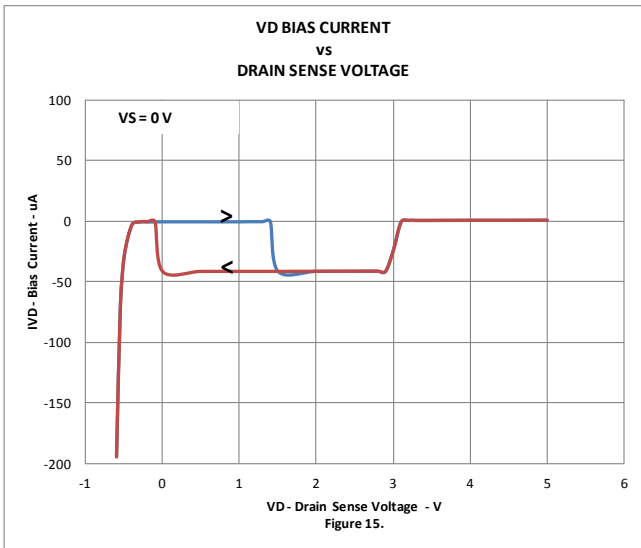
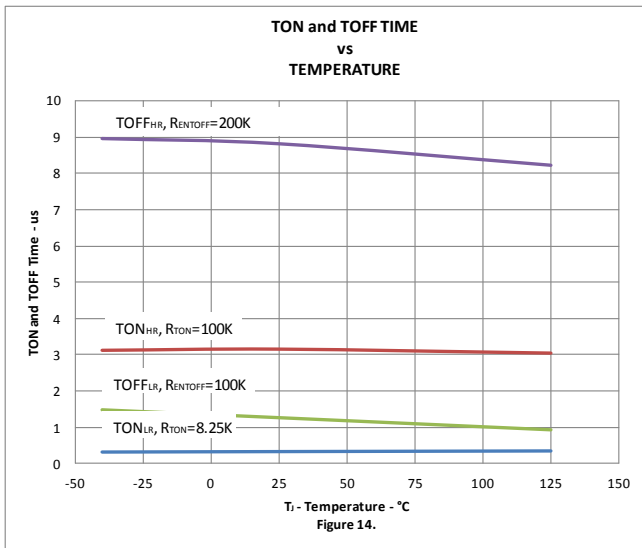
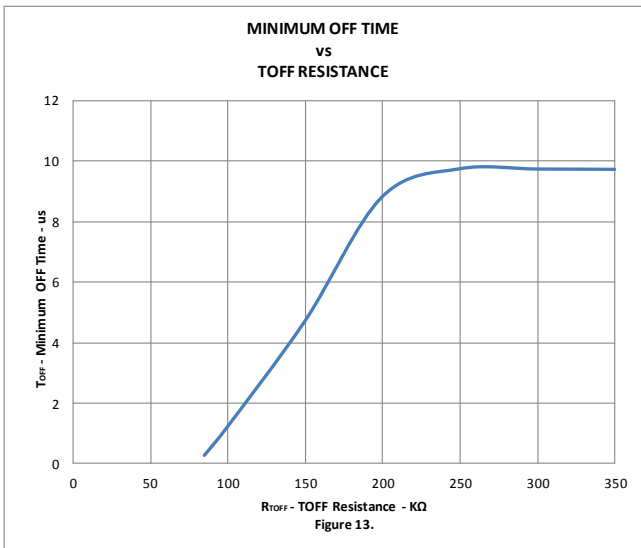
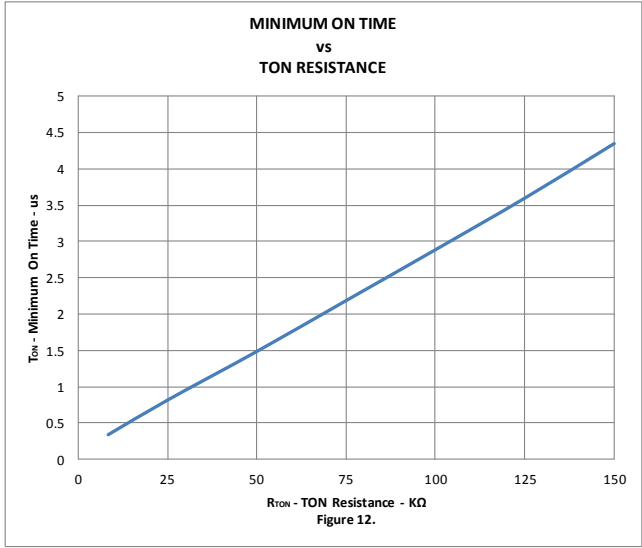
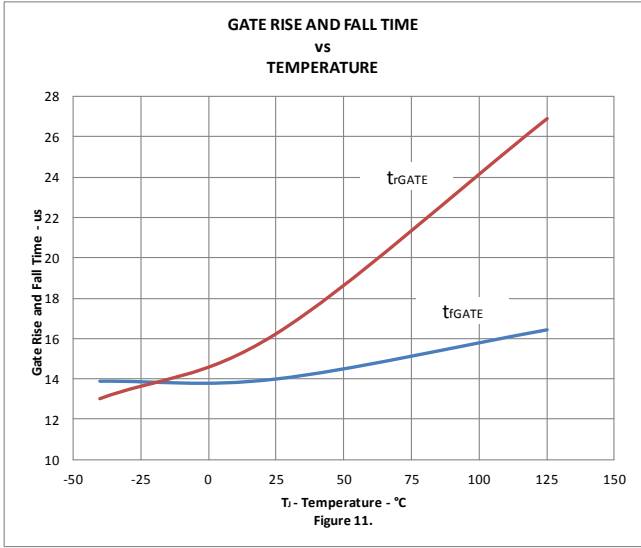

Modes of Operation

General Description

AR2003FV is an Active/Synchronous Rectifier which can work with many different primary side controllers. AR2003FV can be used in both SSR and PSR systems.

AR2003FV has preset of internal feedback resistor that can reduce external BOM for 5V or 12V system.

UVLO MODE

When V_{CC} does not reach $UVLO_{TH}$, or falls below $UVLO_{TH} - UVLO_{HYS}$, AR2003FV will be in UVLO MODE.

In this mode, AR2003FV will turn off external MOSFET, and TOFF/EN pin will internally short to GND. V_{CC} current will be ICC_{START} .

Sleep Mode

Sleep Mode is a low-power operating mode similar to UVLO Mode, except that this mode is entered by forcing V_{EN} below the V_{EN-OFF} threshold via external control. Many internal circuits are turned off to reduce power consumption in this mode to reduce device operating losses. External control overrides any internal timing conditions, and immediately forces the GATE output low and enters Sleep Mode. V_{CC} current is reduced to $ICC_{STANDBY}$ level. As V_{EN} is restored to above the V_{EN-ON} threshold, the device exits Sleep Mode into Light-Load Mode after a delay of several μs , allowing re-powered internal circuits to settle.

Active Mode

This is the normal operation mode when inductor current is large enough and synchronous conduction time is longer than T_{ON} . AR MOSFET will be turned on and off according to $V_D - V_S$, T_{ON} and T_{OFF} setting and SYNC pin.

Light-Load Mode

When Inductor current is small and synchronous conduction time is less than T_{ON} , the AR MOSFET will be kept OFF to reduce switching power loss. Voltage across body diode of AR MOSFET is continuously monitored. When the MOSFET body-diode conduction time is more than T_{ON} , the device will be back to Active mode again.

Over Voltage Protection

Over Voltage mostly likely was an indication of optical coupler short. Therefore, just reporting output error information is not enough. AR2003FV will drive an external FET to create a short situation so that primary side can be set to whole system to restart.

Over Temperature Protection (Only for Secondary-side Synchronous Rectification Application)

When AR2003FV is over heated, AR2003FV will light up the optical coupler to let the primary side deliver very little or no energy so that the whole system will cool down. Hysteresis is set to $+25^{\circ}C$.

Usually, V_{CC} might drop below $UVLO_{TH} - UVLO_{HYS}$ (around 2.8V) due to system load. AR2003FV will enter UVLO mode, and system might restart again. If AR2003FV is over heated again in short time, V_{CC} might be kept around 2.8V. The primary side controller might treat this event as over current or short current, and enters its protection mode.

Over Current Protection

Over Current Protection is not implemented in AR2003FV. Over Current Protection will be carried out in Primary side.

Short Current Protection

Short Current Protection is not implemented in AR2003FV. Short Current Protection handling will be carried out in Primary side.

Application Information

ON Timer Programming

The T_{on} period (minimum on-time) is programmed by adding a resistor from TON pin to ground. In the application, it's likely that when the MOSFET is turned on there will be some ringing generated due to parasitic within the system. The minimum on time will stop the device reacting to this ringing, by blanking out any signal received from the Drain to Source (V_D-V_S) comparator once the device is initially triggered. This will keep the MOSFET turned on for duration of the minimum on-time, irrespective of the V_D-V_S voltage during this period.

If V_D-V_S reaches the gate turn-off threshold within the minimum on-time period, the device will change into Light Load Mode for the next switching cycle. If the load conditions of the system change and the MOSFET turn-off threshold is once again reached once the minimum on-time is over, the device reverts to its nominal mode of operation.

$$T_{ON} (\mu s) = 0.028\mu s * R_{TON} (K\Omega) + 0.1\mu s, 0.24\mu s < T_{ON} < 4.3\mu s, 5K\Omega < R_{TON} < 150K\Omega$$

Enabling and OFF Timer Programming

When $V_{CC} < UVLO$, $TOFF/EN$ is internally connected to ground through a resistor.

If V_{CC} rises above $UVLO$, the chip is in the Sleep Mode, a current source will deliver $20\mu A$ ($I_{EN-START}$) to $TOFF/EN$ pins. If $R_{TOFF} > 70K\Omega$, $V_{TOFF/EN}$ will over $1.4V$ (V_{EN-ON}), AR2003FV will enter Active Mode. And the internal current source will switch to deliver $10\mu A$ (I_{EN-ON}) to $TOFF/EN$ pin. User can program the minimum off-time by choosing proper value for R_{TOFF} .

$$T_{OFF} (\mu s) = 0.083\mu s * (R_{TOFF} (K\Omega) - 81K\Omega), \text{ valid for } 85K\Omega < R_{TOFF} < 200K\Omega$$

User can also program OFF timer by control the $V_{TOFF/EN}$.

$$T_{OFF} (\mu s) = 0.083\mu s * (V_{TOFF/EN} - 0.81V), \text{ valid for } 0.85V < V_{TOFF/EN} < 2V$$

The minimum off-time is the minimum time; the internal MOSFET will be turned off once V_{THOFF} turn off threshold is reached. This avoids the MOSFET accidentally being retriggered by ringing after turn off.

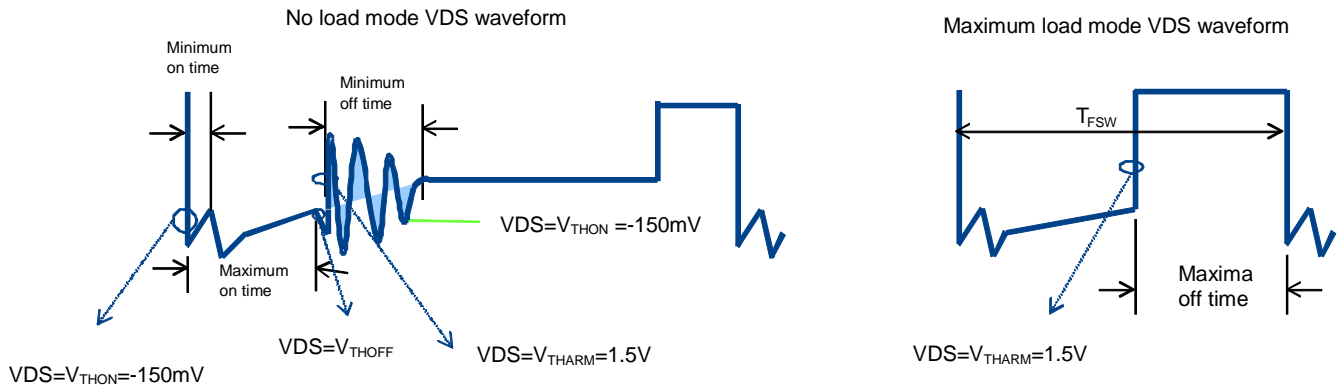

| | | |
|------------------|---|----------------------------------|
| Minimum On Time | >The time from VDS fall under V_{THON} to VDS ringing voltage < V_{THOFF} | Check with no load waveform |
| Maximum On Time | < The time from VDS fall under V_{THON} to $VDS = V_{THOFF}$ | Check with no load waveform |
| Minimum Off Time | > The time from $VDS > V_{THARM}$ to VDS ringing negative voltage higher than V_{THON} after turn off | Check with no load waveform |
| Maximum Off Time | < The time from $VDS = V_{THARM}$ to VDS drop from VCC level | Check with maximum load waveform |

Application Information (Cont.)

SYNC Input Circuit

SYNC pin is internally pulled up to internal AVDD (4.2V to 5V) through a 2KΩ resistor. If a falling edge of more than 2V is detected, the external MOSFET will be turned off by AR2003FV. If the amplitude of SYNC signal is larger than 4.2V, an external resistor should be used to limit the input current less than 2mA.

Ordering Information (Note 9)

| Part Number | Marking | Reel size (inches) | Tape width (mm) | Quantity per reel |
|-------------|---------|--------------------|-----------------|-------------------|
| AR2003FV-13 | AR2003 | 13 | 12 | 3,000 |

Note 9: For packaging details, go to our website at <http://www.diodes.com/products/packages.html>.

Marking Information

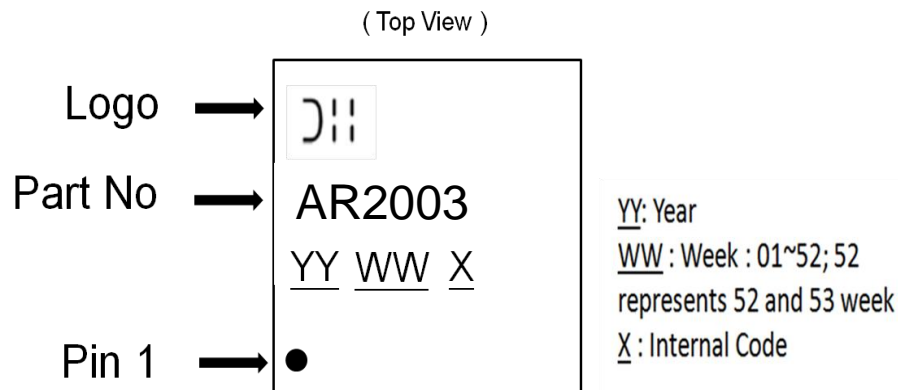

Package Outline Dimensions (All dimensions in mm.)

Please see AP02002 at <http://www.diodes.com/datasheets/ap02002.pdf> for latest version.

(1) Package Type: V-DFN3535-14

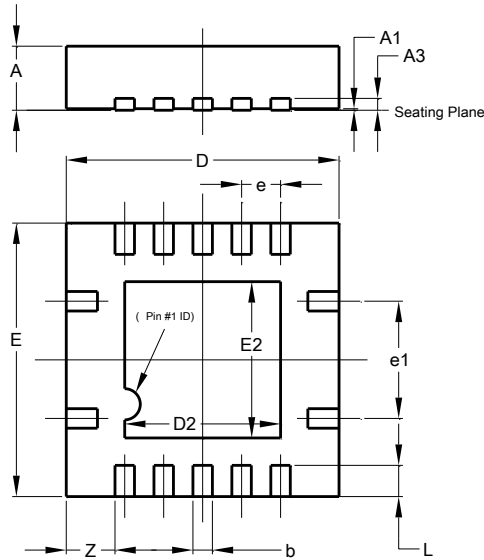

| V-DFN3535-14 | | | |
|----------------------|------|------|-------|
| Dim | Min | Max | Typ |
| A | 0.75 | 0.85 | 0.80 |
| A1 | 0.00 | 0.05 | 0.02 |
| A3 | - | - | 0.15 |
| b | 0.20 | 0.30 | 0.25 |
| D | 3.45 | 3.55 | 3.50 |
| D2 | 1.90 | 2.10 | 2.00 |
| E | 3.45 | 3.55 | 3.50 |
| E2 | 1.90 | 2.10 | 2.00 |
| e | - | - | 0.50 |
| e1 | - | - | 1.50 |
| L | 0.35 | 0.45 | 0.40 |
| Z | - | - | 0.625 |
| All Dimensions in mm | | | |

Suggested Pad Layout

Please see AP02001 at <http://www.diodes.com/datasheets/ap02001.pdf> for the latest version.

(1) Package Type: V-DFN3535-14

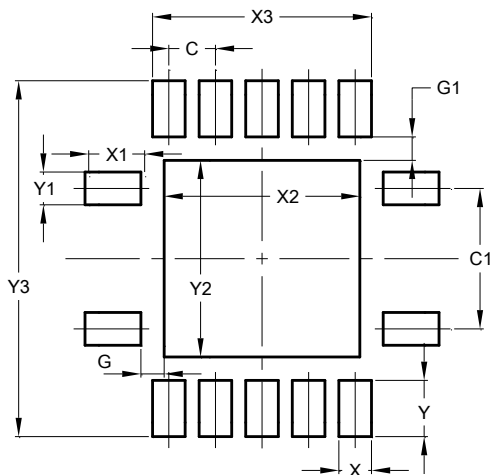

| Dimensions | Value (in mm) |
|------------|---------------|
| C | 0.500 |
| C1 | 1.500 |
| G | 0.250 |
| G1 | 0.250 |
| X | 0.350 |
| X1 | 0.600 |
| X2 | 2.100 |
| X3 | 2.350 |
| Y | 0.600 |
| Y1 | 0.350 |
| Y2 | 2.100 |
| Y3 | 3.800 |

IMPORTANT NOTICE

DIODES INCORPORATED MAKES NO WARRANTY OF ANY KIND, EXPRESS OR IMPLIED, WITH REGARDS TO THIS DOCUMENT, INCLUDING, BUT NOT LIMITED TO, THE IMPLIED WARRANTIES OF MERCHANTABILITY AND FITNESS FOR A PARTICULAR PURPOSE (AND THEIR EQUIVALENTS UNDER THE LAWS OF ANY JURISDICTION).

Diodes Incorporated and its subsidiaries reserve the right to make modifications, enhancements, improvements, corrections or other changes without further notice to this document and any product described herein. Diodes Incorporated does not assume any liability arising out of the application or use of this document or any product described herein; neither does Diodes Incorporated convey any license under its patent or trademark rights, nor the rights of others. Any Customer or user of this document or products described herein in such applications shall assume all risks of such use and will agree to hold Diodes Incorporated and all the companies whose products are represented on Diodes Incorporated website, harmless against all damages.

Diodes Incorporated does not warrant or accept any liability whatsoever in respect of any products purchased through unauthorized sales channel. Should Customers purchase or use Diodes Incorporated products for any unintended or unauthorized application, Customers shall indemnify and hold Diodes Incorporated and its representatives harmless against all claims, damages, expenses, and attorney fees arising out of, directly or indirectly, any claim of personal injury or death associated with such unintended or unauthorized application.

Products described herein may be covered by one or more United States, international or foreign patents pending. Product names and markings noted herein may also be covered by one or more United States, international or foreign trademarks.

This document is written in English but may be translated into multiple languages for reference. Only the English version of this document is the final and determinative format released by Diodes Incorporated.

LIFE SUPPORT

Diodes Incorporated products are specifically not authorized for use as critical components in life support devices or systems without the express written approval of the Chief Executive Officer of Diodes Incorporated. As used herein:

A. Life support devices or systems are devices or systems which:

1. are intended to implant into the body, or
2. support or sustain life and whose failure to perform when properly used in accordance with instructions for use provided in the labeling can be reasonably expected to result in significant injury to the user.

B. A critical component is any component in a life support device or system whose failure to perform can be reasonably expected to cause the failure of the life support device or to affect its safety or effectiveness.

Customers represent that they have all necessary expertise in the safety and regulatory ramifications of their life support devices or systems, and acknowledge and agree that they are solely responsible for all legal, regulatory and safety-related requirements concerning their products and any use of Diodes Incorporated products in such safety-critical, life support devices or systems, notwithstanding any devices- or systems-related information or support that may be provided by Diodes Incorporated. Further, Customers must fully indemnify Diodes Incorporated and its representatives against any damages arising out of the use of Diodes Incorporated products in such safety-critical, life support devices or systems.

Copyright © 2014, Diodes Incorporated

www.diodes.com